

A-A

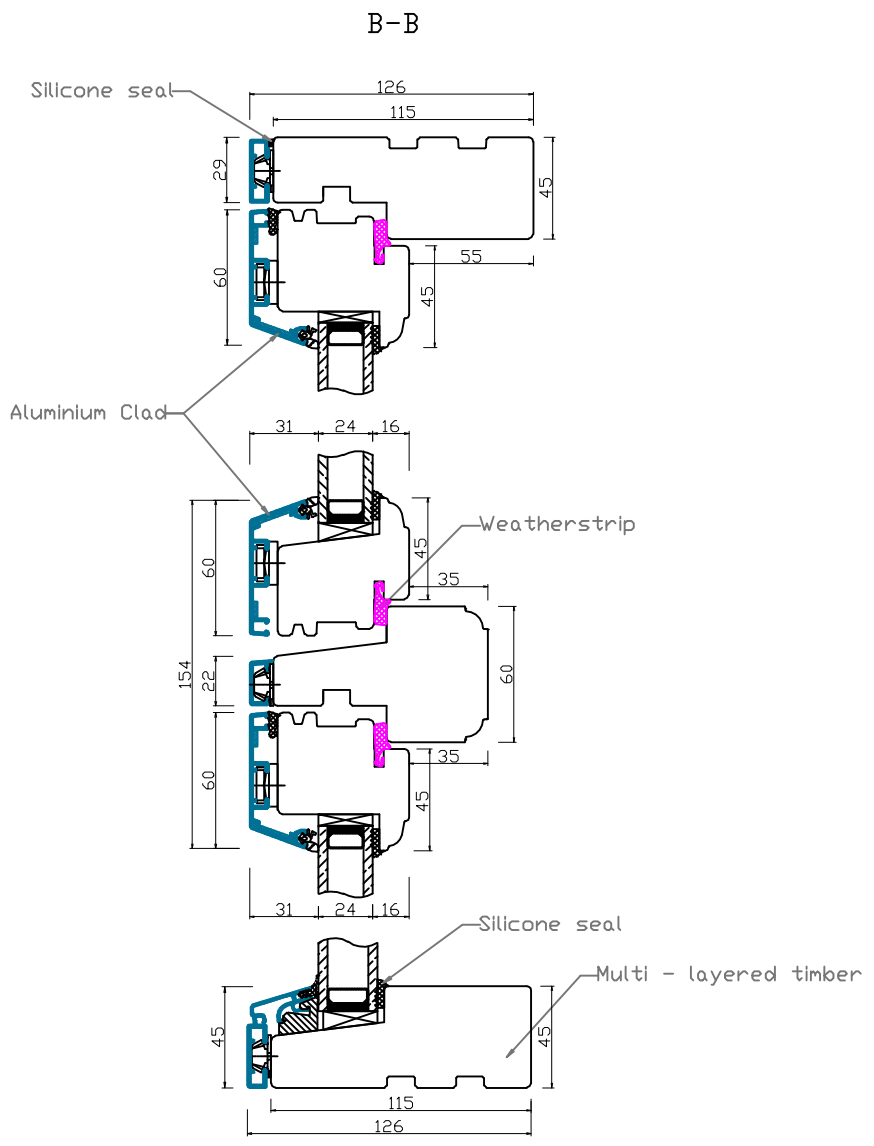

B-B

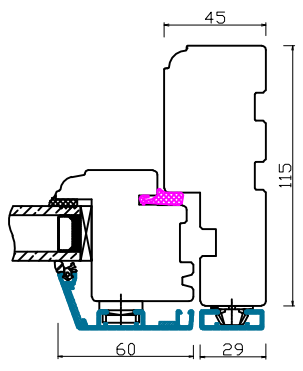
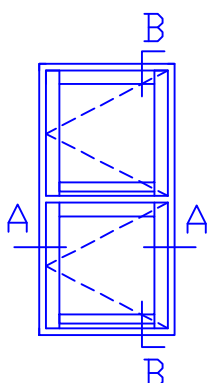

ADDITIONAL OPTIONS

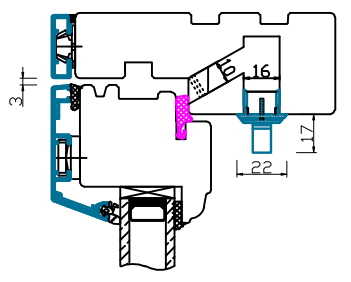

TRICKLE AIR VENT

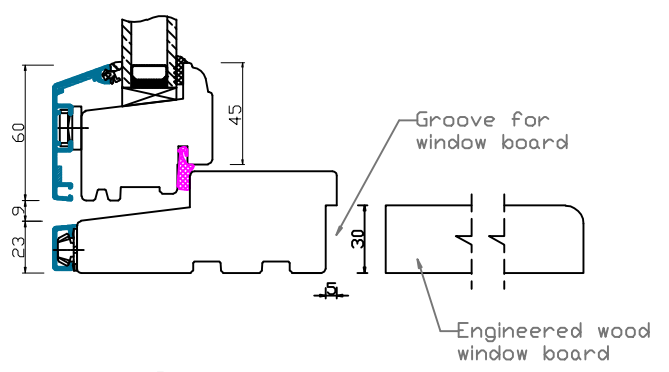

Groove for window board
Engineered wood window board

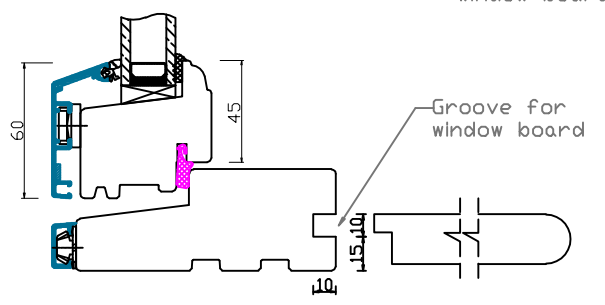

Groove for window board

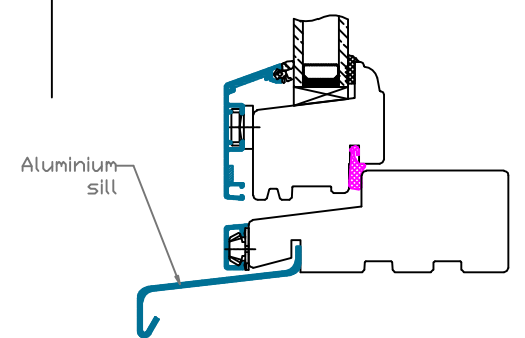

ALUMINIUM SILL

Natural Windows Ltd
 10 Park Parade, Gunnersbury Avenue, London W3 9BD
 www.naturalwindows.com info@naturalwindows.com

Object: CW8
 PROFILE ALUX
 ALUMINIUM CLAD
 SIDE HUNG OR SIDE SWING