

ADDITIONAL OPTIONS

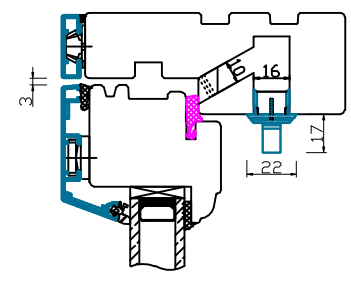

TRICKLE AIR VENT

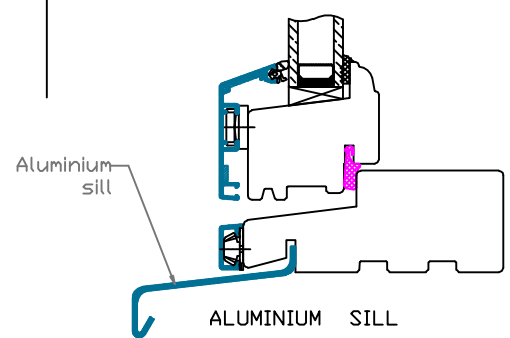
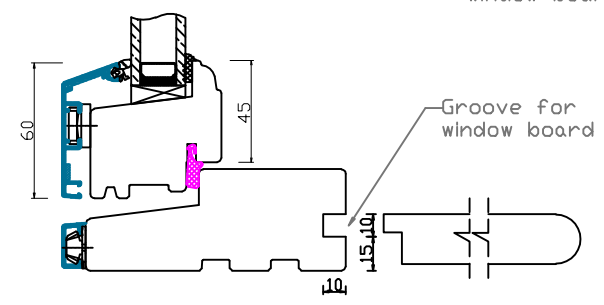
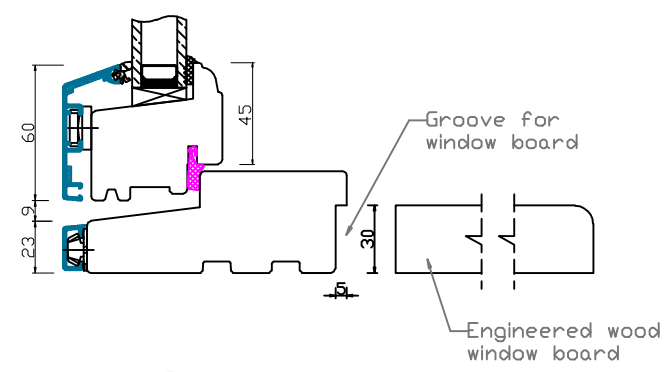

D-D

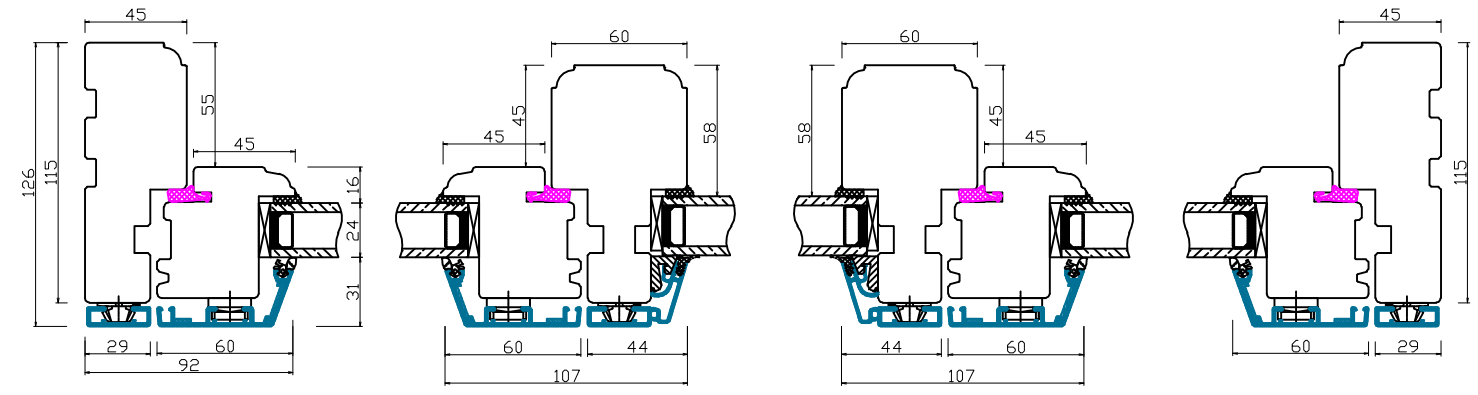

C-C

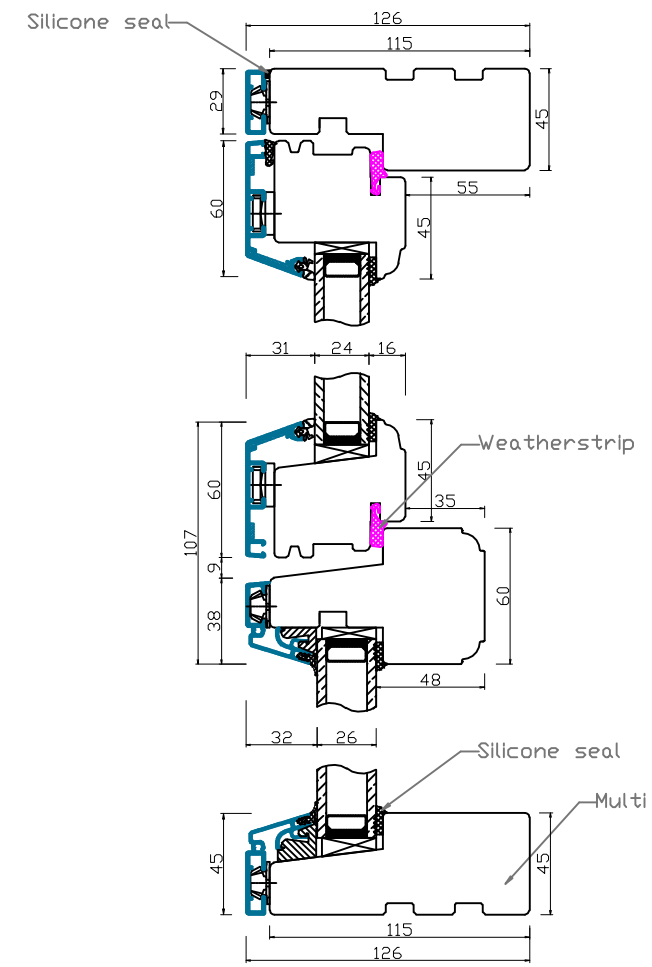

B-B

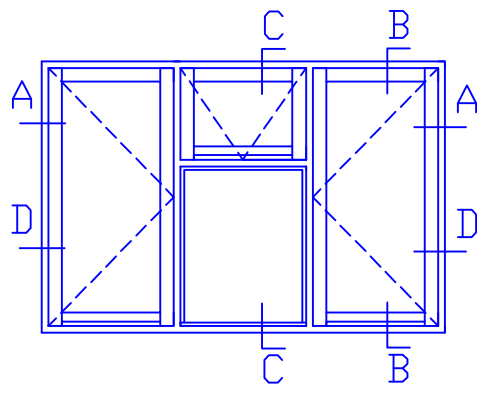
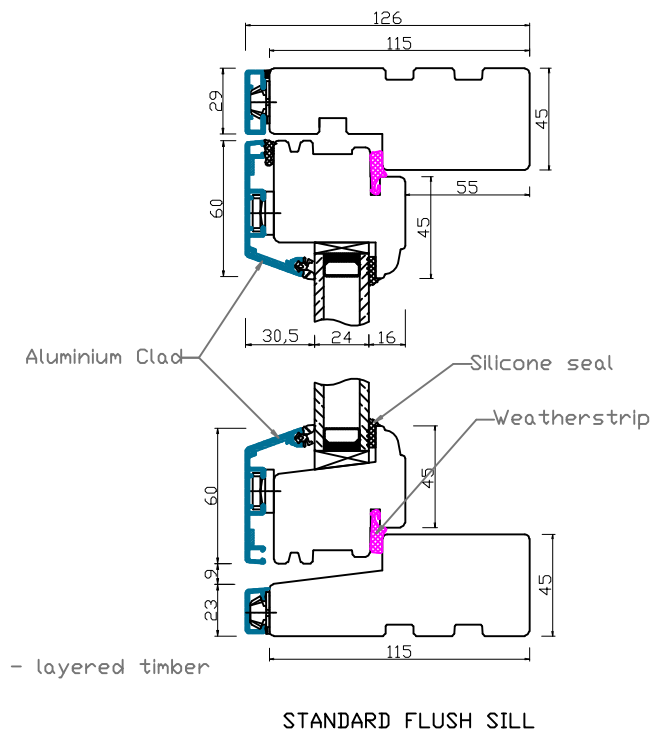

Natural Windows Ltd
10 Park Parade, Gunnersbury Avenue, London W3 9BD
www.naturalwindows.com info@naturalwindows.com

Object: CW11
PROFILE ALUX
ALUMINIUM CLAD
SIDE HUNG OR SIDE SWING COMBINED
WITH TOP SWING