

designs on glass



  
**AC YULE**

"Our mission is to be the best service and product supplier within our business and to be acknowledged as such."

# Contents

Fanlights	4-6	Decorative bevel fanlights	18-19
Flowing fanlights	7-8	Bevel clusters for bespoke designs	20-22
Side lights	9	Corner bevel clusters for bespoke designs	23
Door Panels	10-11	Simple bevels & numbers for bespoke designs	24
Lead designs	12	Commercial applications	25
Brilliant cut designs	13	Translucent Colour Range	26
Sand blasted designs	14-16	Marble Colour Range	27
Decorative bevel doors	17		

## Introduction

AC Yule, a long established glass processor, have over 60 years experience in the design, manufacture and installation of decorative glass designs for your home or commercial application. Through years of knowledge of the glass industry we ensure that the highest quality of materials are used - combined with the best craftsmen we produce a product of exceptional standards.

'Designs on Glass' aims to provide a wide range of design ideas to add that something extra to your home. For that individual look however, our team

of designers can help you create your own designs, maybe to match existing panels or fit your present colour schemes.

Whether it's decorative panels, bevel clusters or sandblasted designs this range is by no means exhaustive, all products are made to order so you can choose your own colours and designs.

Bring some extra charm to your house, workplace or establishment with decorative glass designs from AC Yule.

# Fanlights

The selection of fanlights combines a range of floral designs with some modern patterns allowing your window designs to merge with existing decor. The more intricate patterns provide a truly unique concept to add to your home. All designs and colours can be adapted to suit your own requirements.

Traditional stained glass windows can be copied creating replacement windows that look original.

See pages 26 & 27 for colours.

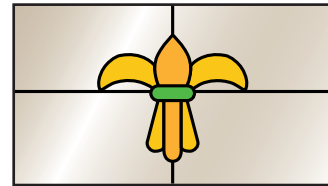

FL/01/A

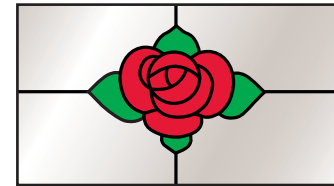

FL/02/A

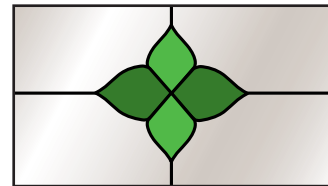

FL/03/A

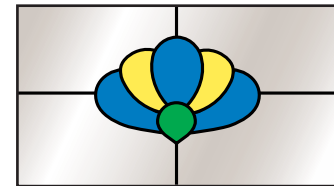

FL/04/A

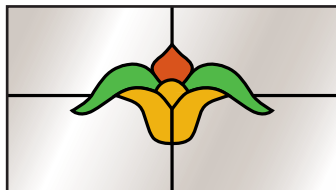

FL/05/A

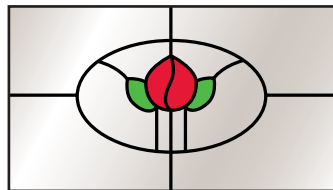

FL/06/A

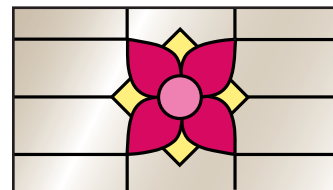

FL/07/A

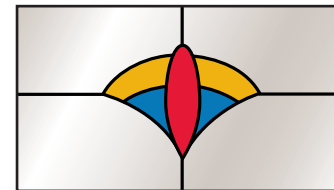

FL/08/A

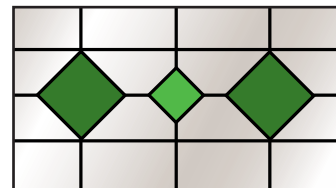

FL/09/A

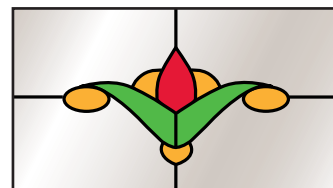

FL/10/A

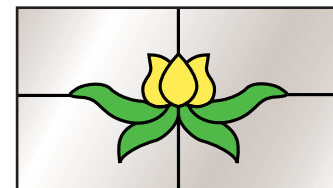

FL/11/A

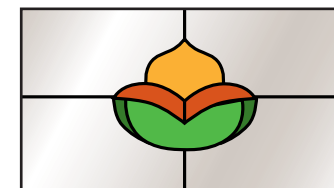

FL/12/A

# Fanlights

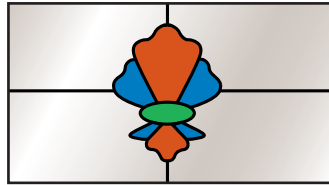

FL/13/A



FL/14/B

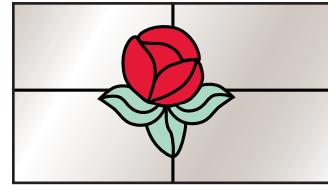

FL/15/B

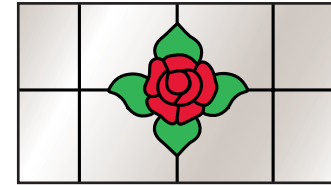

FL/16/B

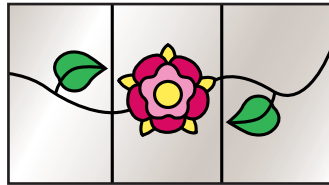

FL/17/B

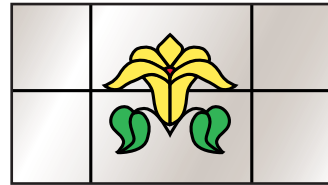

FL/18/B

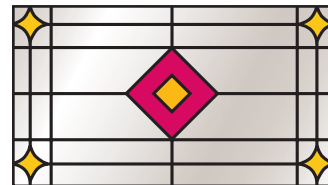

FL/19/B



FL/20/B



FL/21/B

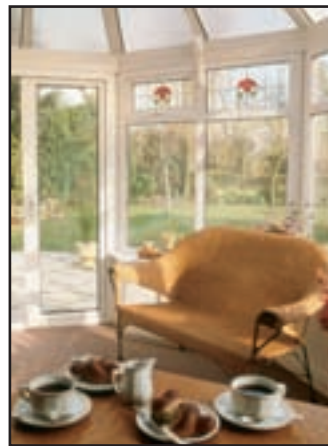

FL/22/B

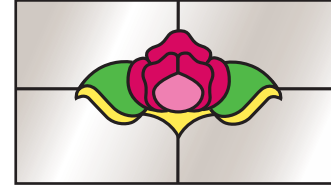

FL/23/B

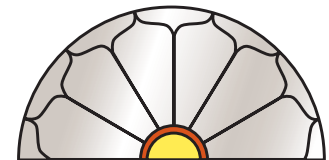

FL/24/B



FL/25/B

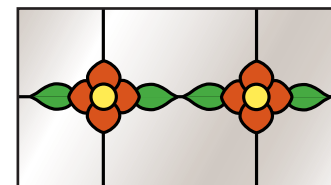

FL/26/B

# Fanlights

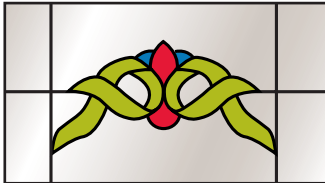

FL/27/B

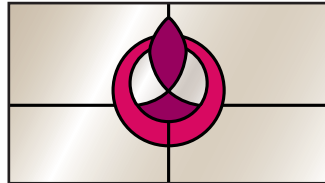

FL/28/B

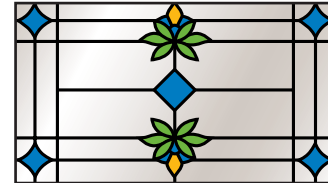

FL/29/C

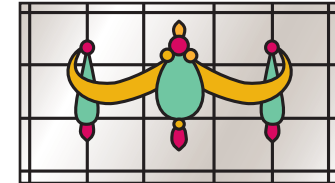

FL/30/C

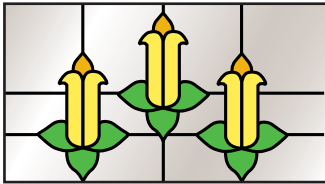

FL/31/C

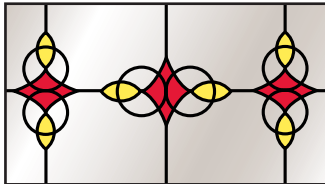

FL/32/C

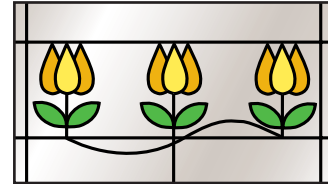

FL/33/C

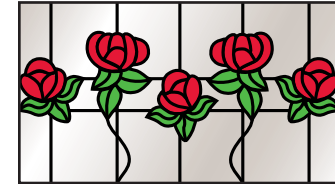

FL/34/C

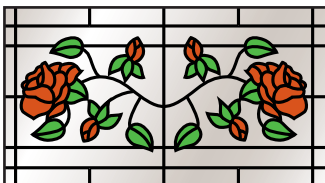

FL/35/C

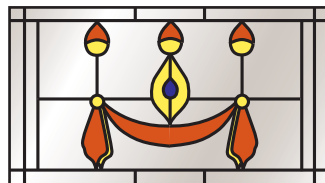

FL/36/C

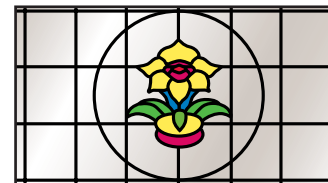

FL/37/C



FL/38/C



FL/39/C

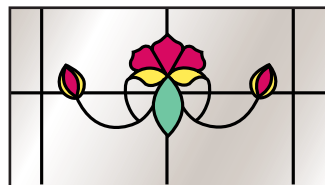

FL/40/C

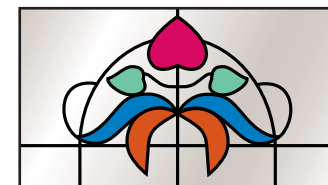

FL/41/C

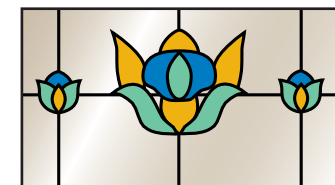

FL/42/C

## Flowing fanlights

This exciting new range of designs specially made for conservatories and bay windows adds that touch of class and individuality to fanlight designs. As with all our collections individual patterns can be created.

See pages 26 & 27 for colours

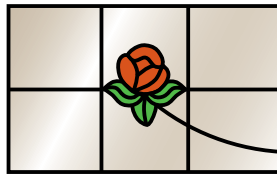

FF/01/A

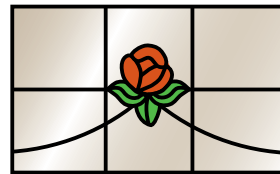

FF/01/B

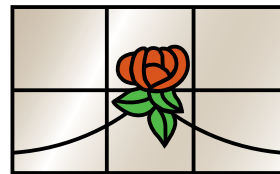

FF/01/C

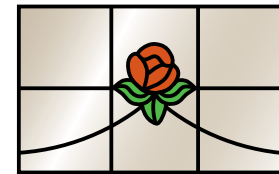

FF/01/D

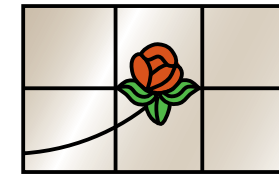

FF/01/E

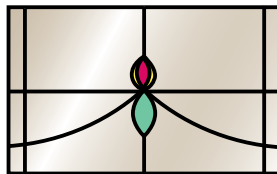

FF/02/A

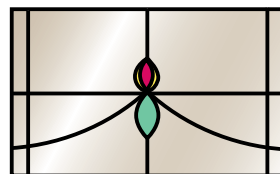

FF/02/B

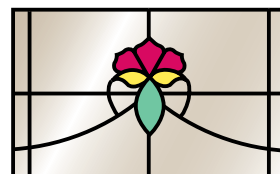

FF/02/C

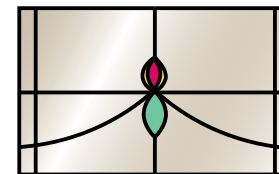

FF/02/D

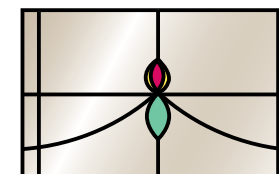

FF/02/E

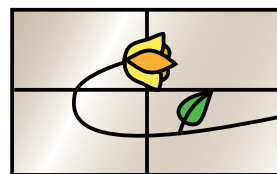

FF/03/A

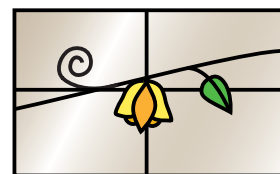

FF/03/B

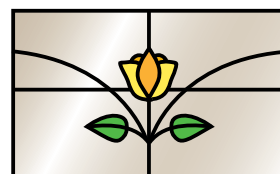

FF/03/C

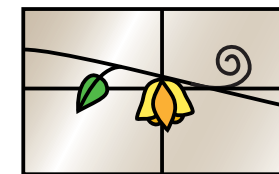

FF/03/D

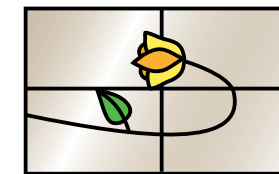

FF/03/E

# Flowing fanlights

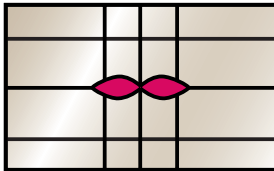

FF/04/A

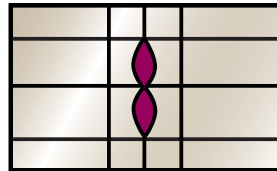

FF/04/B

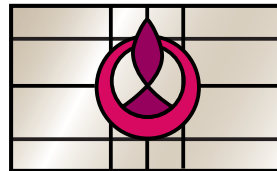

FF/04/C

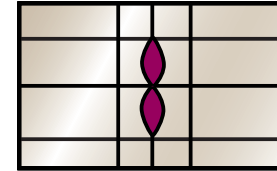

FF/04/D

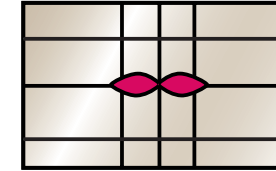

FF/04/E

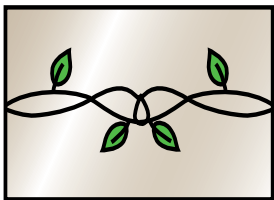

FF/05/A

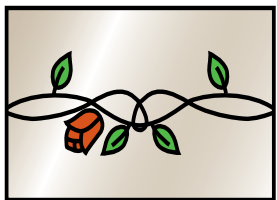

FF/05/B

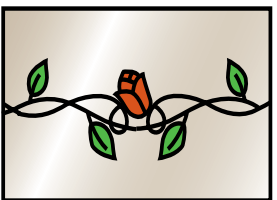

FF/05/C

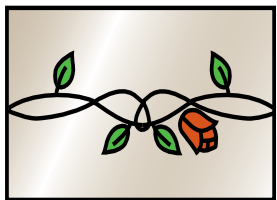

FF/05/D

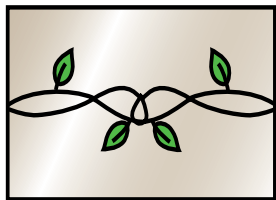

FF/05/E

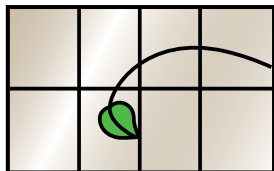

FF/06/A

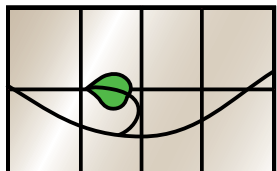

FF/06/B

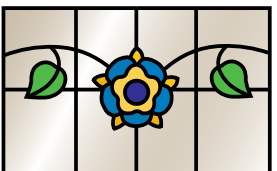

FF/06/C



FF/06/D

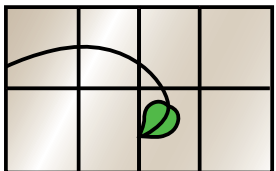

FF/06/E

## Side lights

Similar works have been created in side lights to enable you to co-ordinate your chosen fanlight or door panel with the designs shown here.

As with all our designs the colours and style can be chosen to suit your requirements.

See pages 26 & 27 for colours

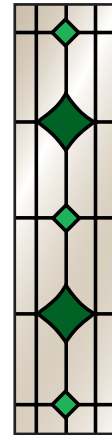

SL/01



SL/02



SL/03



SL/04

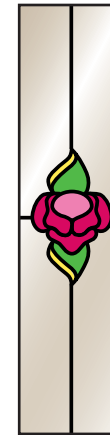

SL/05

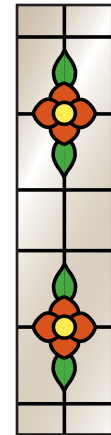

SL/06

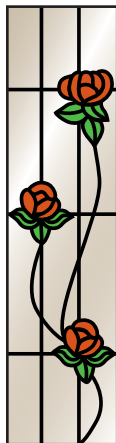

SL/07



SL/08



SL/09

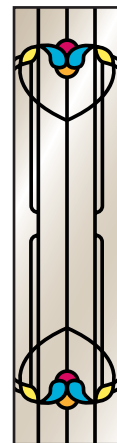

SL/10



SL/11



SL/12



SL/13



SL/14

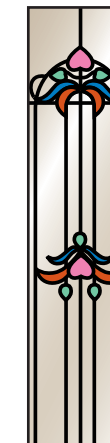

SL/15

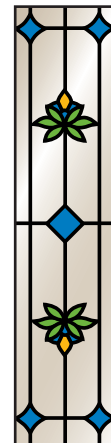

SL/16

## Door panels

Let your door create the atmosphere to your home with this range of decorative door panels. This range of inspirational design opportunities can transform the simplest of doors either external or internal.

See pages 26 & 27 for colours

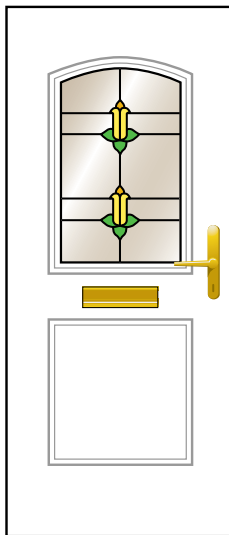

DP/01

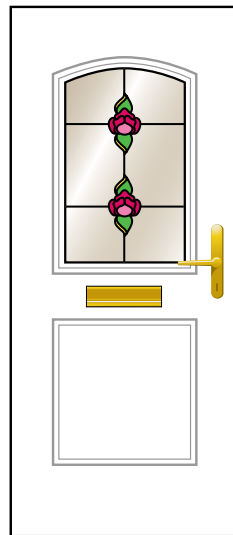

DP/02

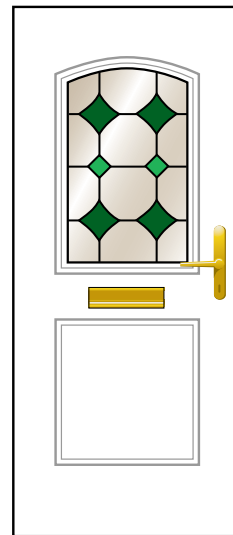

DP/03

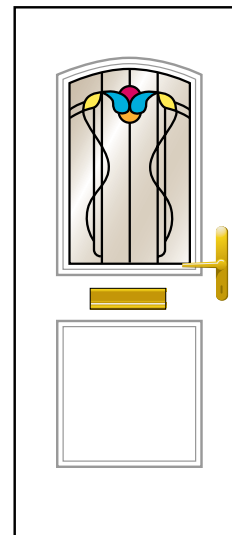

DP/04

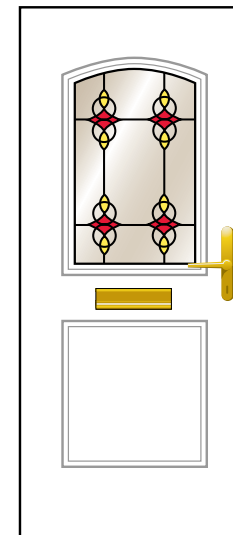

DP/05

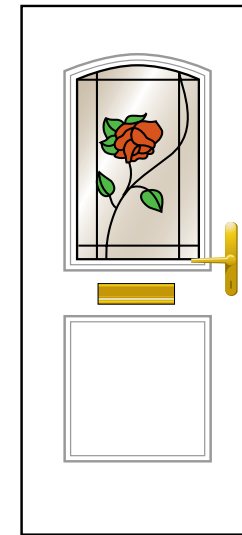

DP/06

# Door panels

See pages 26 & 27 for colours

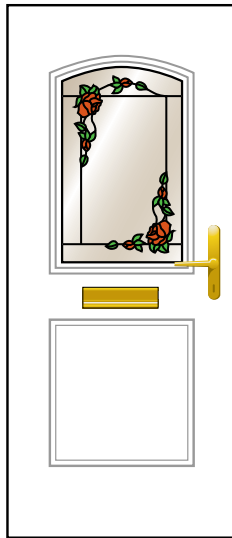

DP/10

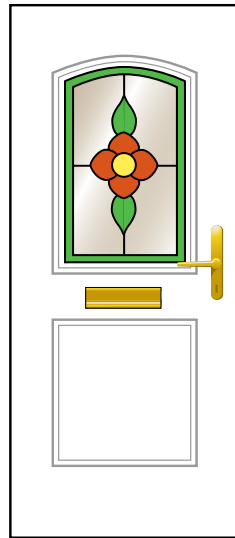

DP/11

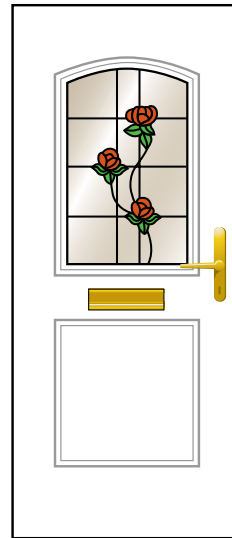

DP/12

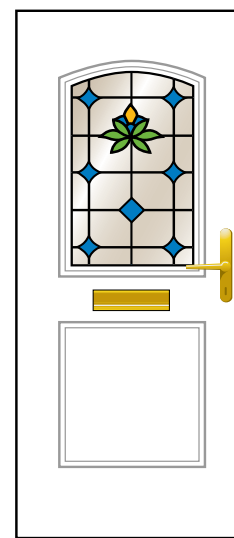

DP/07

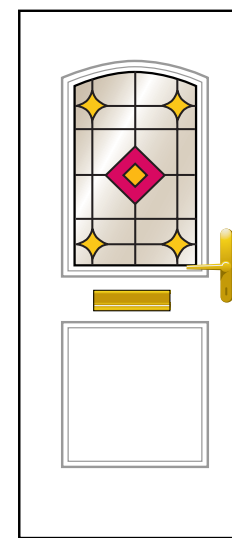

DP/08

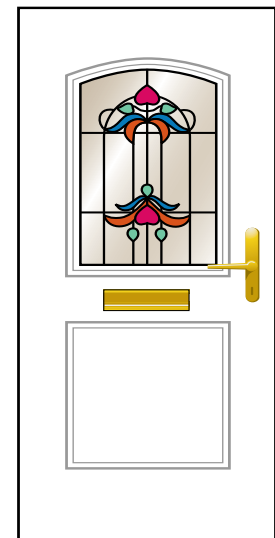

DP/09

## Lead designs

The Lead Collection will make the creation of traditional lead windows a reality for everyone. For something a little simpler, our range of lead designs are available in lead or brass effect strip, the traditional lead look window has grown in popularity.



LD/01

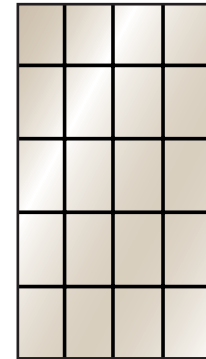

LD/02

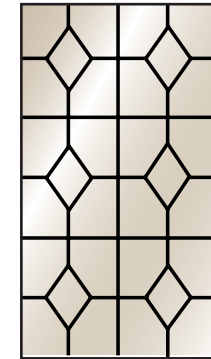

LD/03

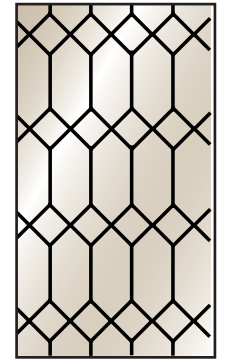

LD/04

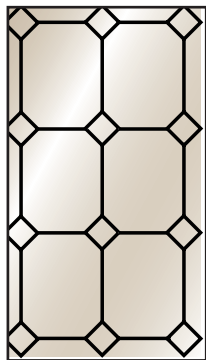

LD/05

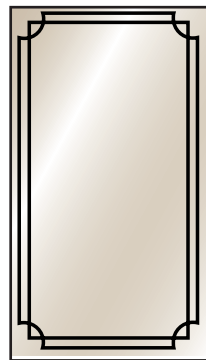

LD/06

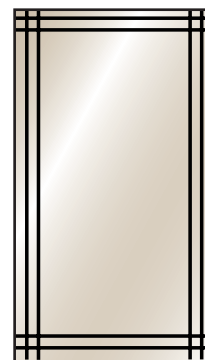

LD/07

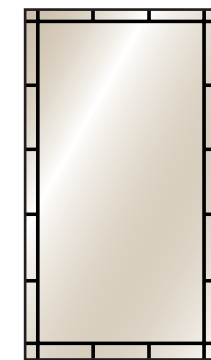

LD/08

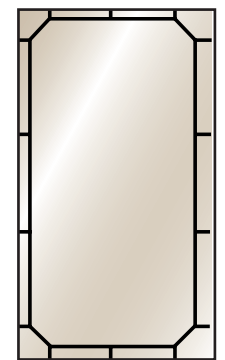

LD/09

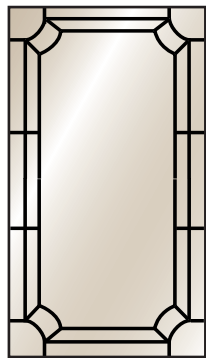

LD/10

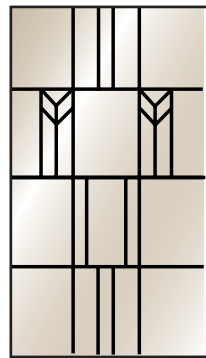

LD/11

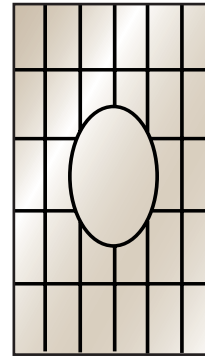

LD/12

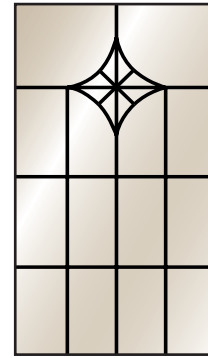

LD/13

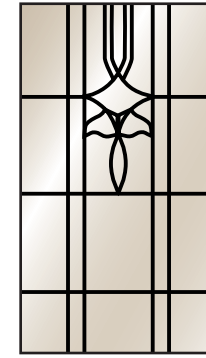

LD/14

## Brilliant cut designs

Brilliant cutting will transform an ordinary piece of glass into the focal point of any room. The design is cut into the glass and again can be tailored to your own requirements. Brilliant cut designs look particularly striking on mirrors, suitable for the bathroom or bedroom.

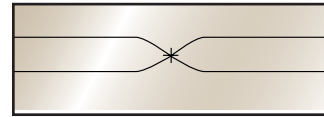

BC/01



BC/02

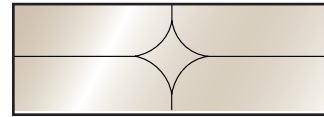

BC/03

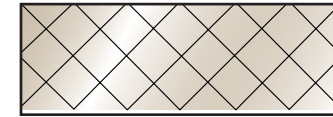

BC/04

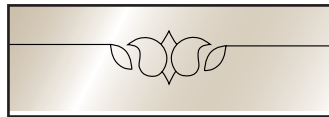

BC/05

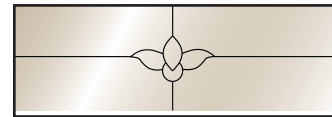

BC/06

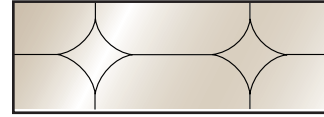

BC/07



BC/08



BC/09

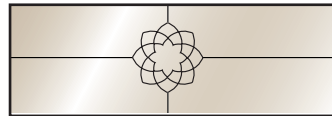

BC/10

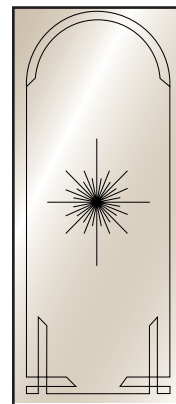

BC/11

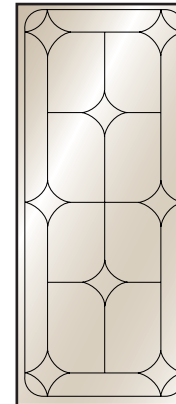

BC/12

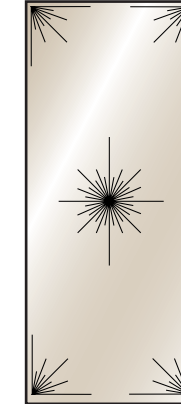

BC/13

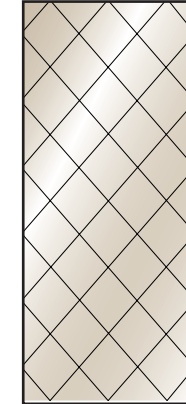

BC/14

## Sandblasted designs

Sandblasted and etched designs can be used to create totally ornate designs or you can choose from our range of standard designs. All designs can be matched with borders or display house numbers and names.

Designs can be created for any size and shape of glass.



SD/01



SD/02



SD/03



SD/04



SD/05



SD/06



SD/07



SD/08



SD/09



SD/10



SD/11



SD/12



SD/13



SD/14



SD/15



SD/16



SD/17



SD/18



SD/19

# Sandblasted designs



SD/20



SD/21

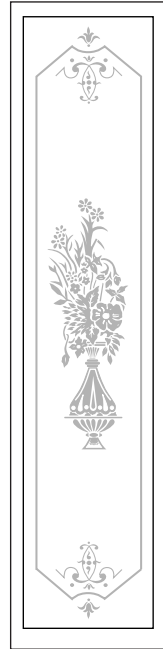

SD/22

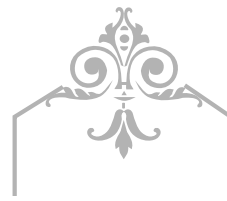

SD/23

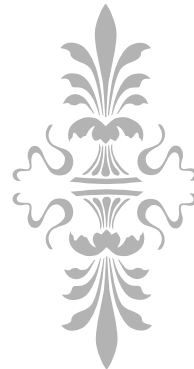

SD/24

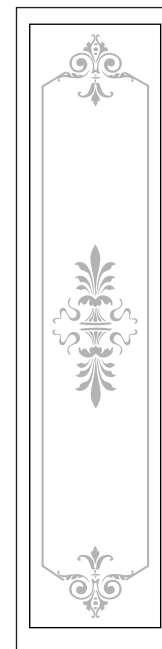

SD/25



SD/26

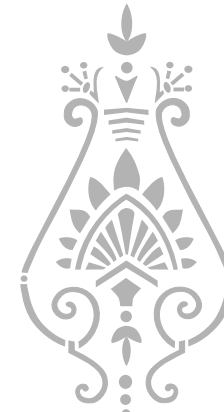

SD/27

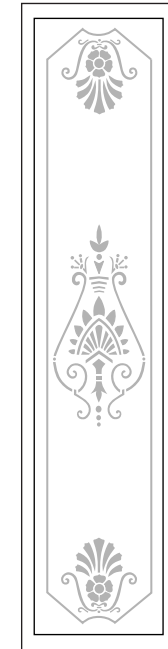

SD/28

# Sandblasted designs



SD 29



SD 30



SD 31



SD 32



SD 33



SD 34



SD 35



SD 36



SD 37



SD 38



SD 39

## Decorative bevel doors

Continually developing the concept of creative options, we provide this extensive range of Bevel Cluster options. Bevel Clusters can compliment the use of lead and coloured work, finishing your decorative glass creations. All Bevel Clusters can be coloured selecting from any colour from pages 26 & 27 using either traditional lead or brass effect finish.



DD/01



DD/02



DD/03



DD/04



DD/05



DD/06

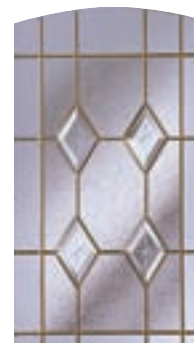

DD/07



DD/08

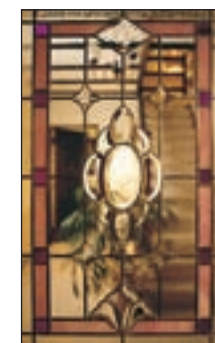

DD/09

## Decorative bevel fanlights



DF/01



DF/02



DF/03



DF/04



DF/05



DF/06

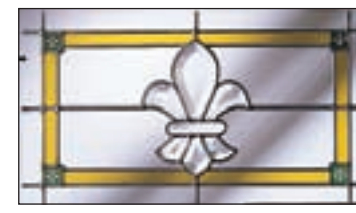

DF/07



DF/08



DF/09



DF/10



DF/11



DF/12

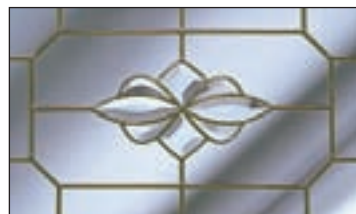

DF/13



DF/14



DF/15



DF/16

# Decorative bevel fanlights



DF/17

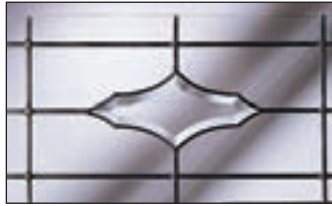

DF/18



DF/19



DF/20



DF/21



DF/22



DF/23



DF/24



DF/25



DF/26

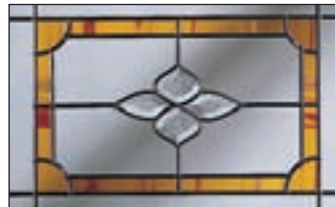

DF/27



DF/28

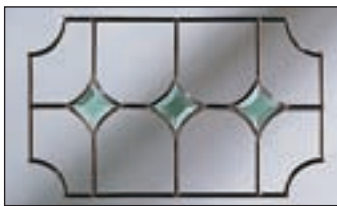

DF/29



DF/30

# Bevel clusters for bespoke designs

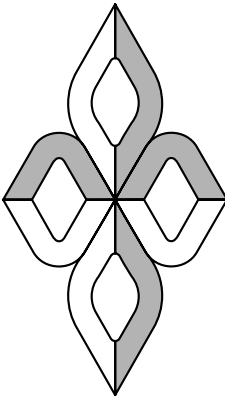

AC 5.2  
145mm x 229mm

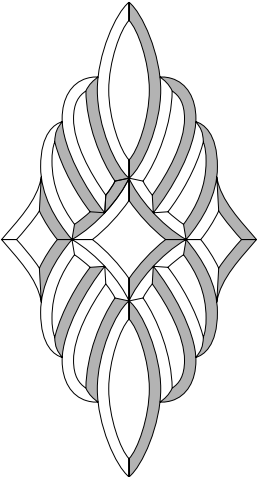

AC 15.1  
283mm x 520mm

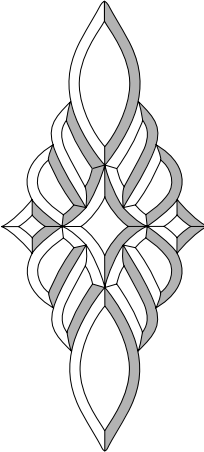

AC 340  
257mm x 565mm

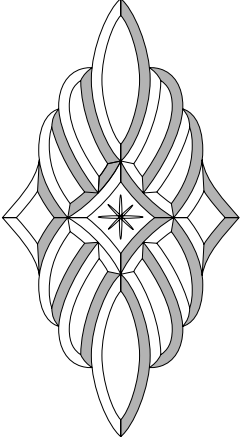

AC 59.1  
283mm x 520mm

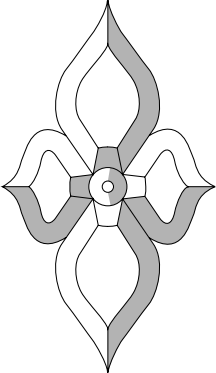

AC 28.1  
200mm x 346mm

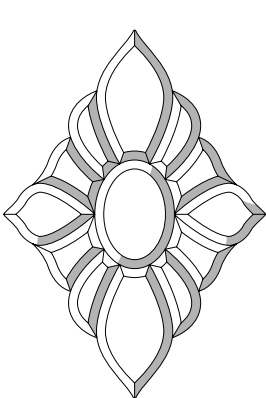

AC 60.1  
360mm x 510mm

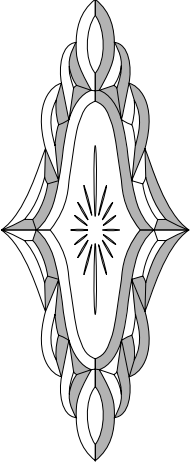

AC 62.2  
276mm x 679mm

## Bevel clusters for bespoke designs

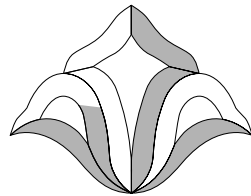

AC 2.1  
165mm x 127mm

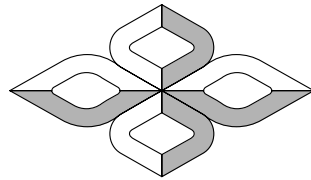

AC 5.1  
191mm x 114mm

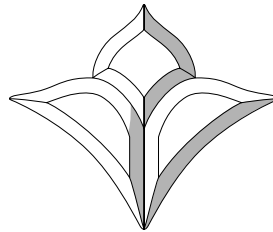

AC 56.1  
185mm x 156mm

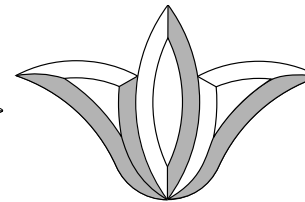

AC 13.1  
224mm x 125mm

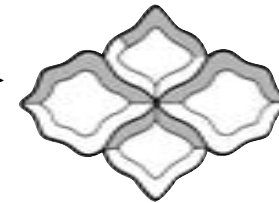

AC 233  
215mm x 155mm

AC 5.2  
229mm x 145mm

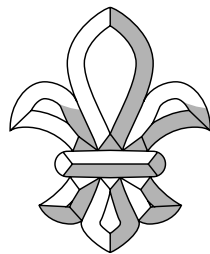

AC 49.1  
145mm x 180mm

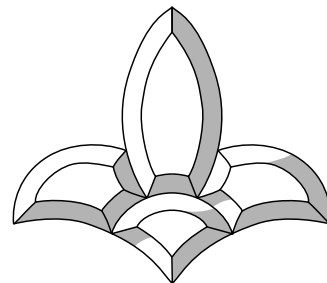

AC 67.1  
228mm x 194mm

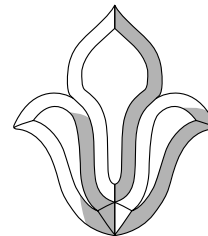

AC 57.1  
134mm x 153mm

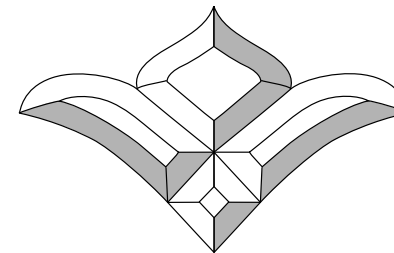

AC 81.1  
216mm x 152mm

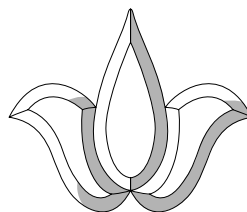

AC 58.1  
182mm x 152mm

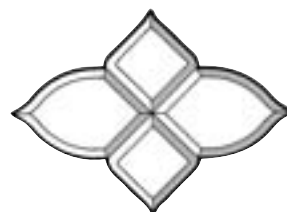

AC 202.1  
225mm x 150mm

## Bevel clusters for bespoke designs

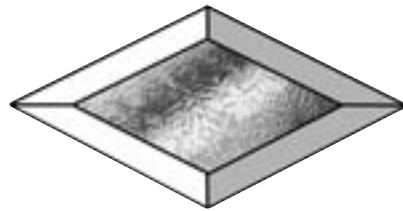

AC 39.1 127mm x 76mm  
AC 39.2 152mm x 102mm  
AC 39.4 100mm x 50mm



AC 40.1  
51mm x 51mm

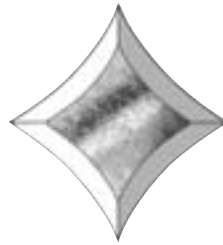

AC 46.1  
82mm x 82mm



AC 469  
152mm x 152mm

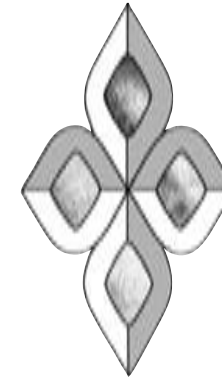

AC 45.1 191mm x 114mm  
AC 45.2 229mm x 145mm



AC 401  
460mm x 220mm

PLEASE NOTE  
Star Bevels dimensions  
are point to point as  
shown.



AC 485  
150mm x 120mm

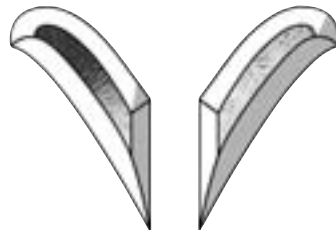

AC 486



AC 485 WITH AC 486  
235mm x 190mm



AC 41.1  
203mm x 355mm



AC 424  
603mm x 292mm

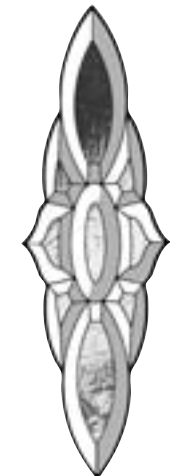

AC 402  
397mm x 112mm

## Corner bevel clusters for bespoke designs

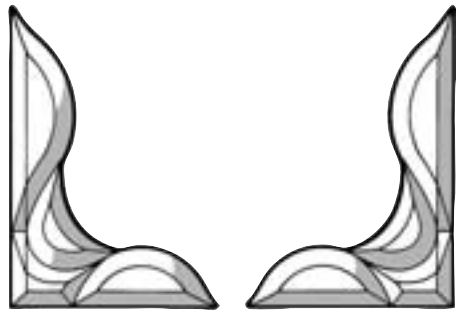

AC 327  
(L) 233mm x 160mm (R) 233mm x 160mm



AC 326  
228mm x 228mm



AC 322  
(L) 152mm x 117mm (R) 152mm x 117mm

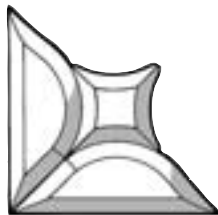

AC 321  
137mm x 137mm



AC 328  
145mm x 145mm



AC 323  
130mm x 130mm



AC 320  
152mm x 152mm

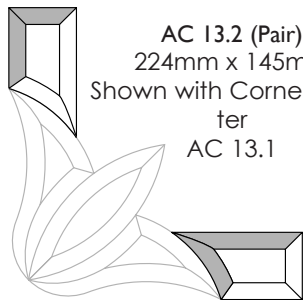
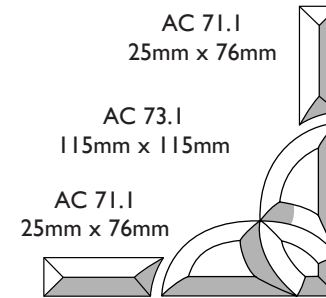

AC 13.2 (Pair)  
224mm x 145mm  
Shown with Corner Cluster  
AC 13.1



AC 325  
(L) 257mm x 194mm (R) 257mm x 194mm

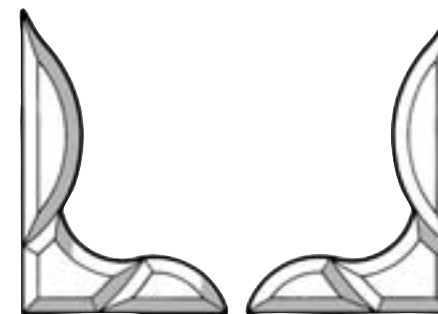

AC 318  
(L) 231mm x 168mm (R) 231mm x 168mm



AC 384  
355mm x 355mm

## Simple bevels & numbers for bespoke designs

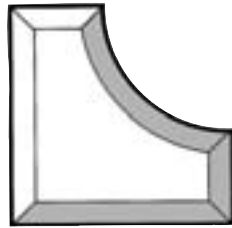

AC 204.1  
125mm x 125mm x 51mm

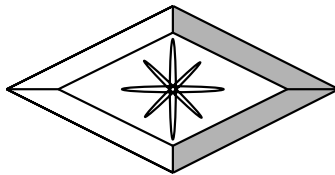

POLISHED BRILLIANT CUT  
AC 1258.1 POL 76mm x 127mm  
AC 1260.1 POL 101mm x 178mm

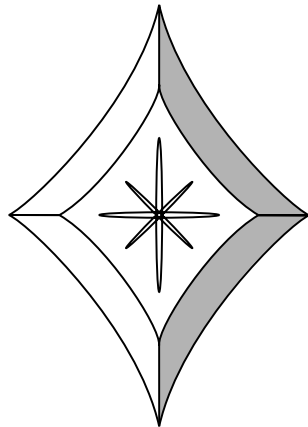

AC 36.1  
190mm x 136mm

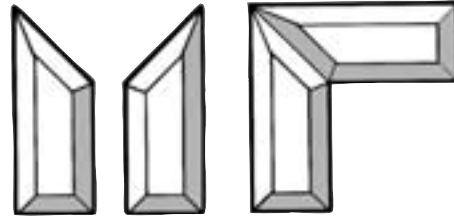

AC 124 CB  
51mm x 101mm

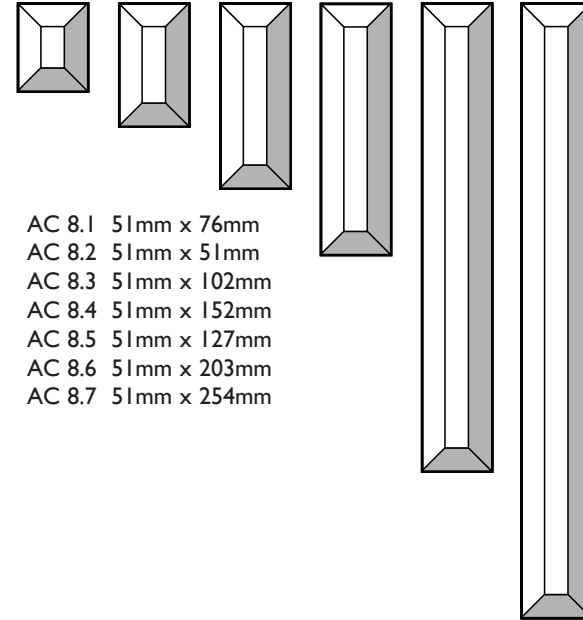

AC 8.1 51mm x 76mm  
AC 8.2 51mm x 51mm  
AC 8.3 51mm x 102mm  
AC 8.4 51mm x 152mm  
AC 8.5 51mm x 127mm  
AC 8.6 51mm x 203mm  
AC 8.7 51mm x 254mm

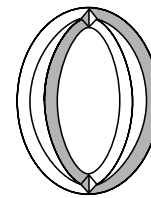

AC 100.0  
100mm High

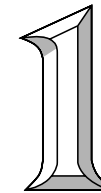

AC 100.1  
100mm High



AC 100.2  
100mm High



AC 100.3  
100mm High

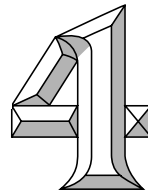

AC 100.4  
100mm High



AC 100.5  
100mm High

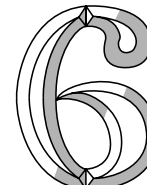

AC 100.6  
100mm High

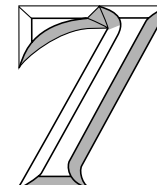

AC 100.7  
100mm High

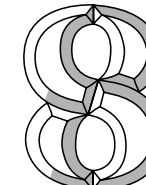

AC 100.8  
100mm High



AC 100.9  
100mm High

## Commercial applications

All the processes shown in this brochure can be particularly adapt at enhancing corporate identities. Logos can be subtly etched on glass entrances or coloured to match colour schemes.

AC Yule's glass knowledge allows specialist glass solutions to be provided for every corporate requirement be it signage, reception counters, tables or privacy screens.



Glass structure incorporating painted sandblasting

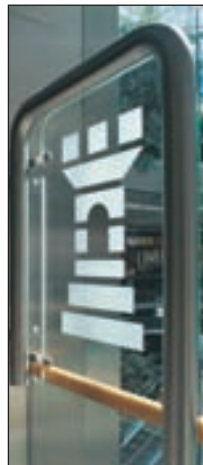

Sandblasted logo



Reverse sandblasting

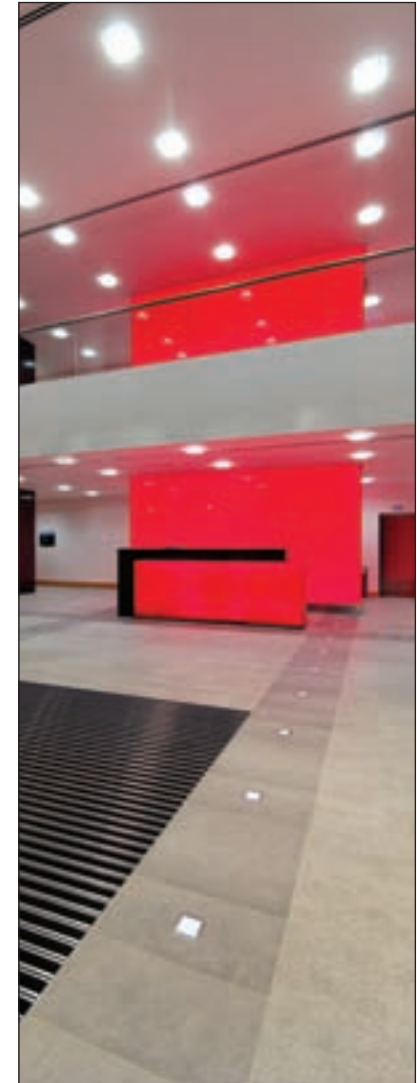

Glass structure

## Translucent colour range

To compliment your own colour schemes please select your chosen colours from this range. The colours in any design in this brochure can be changed to suit your requirements.



## Marble colour range

The Marble Colour Range can be used to add that special effect to your chosen design, particularly effective when used in conjunction with the Translucent Colour Range.



GREEN PEPPER



CANARY MARBLE



CADMIUM



VERMILLION



DEEP RED

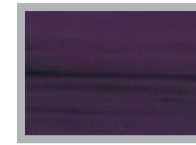

VIOLET



ROSEWOOD



SKY BLUE



ELECTRIC BLUE



SAP GREEN



LAUREL GREEN

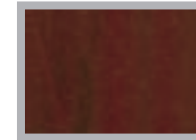

WALNUT BROWN



CARNELIAN

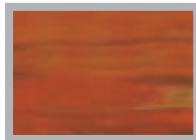

AMBER

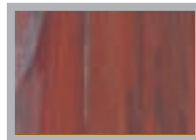

MUSTARD

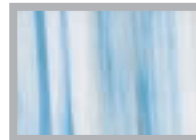

FOG GREY

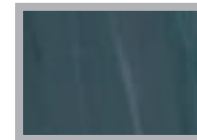

GRANITE

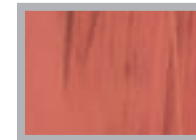

PEACH



PASTEL PINK



LAVENDER

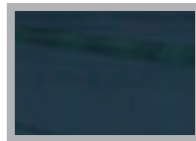

GREY BLUE



SAPPHIRE



KIWI

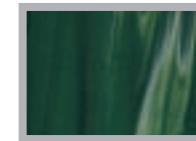

MOSS

Every care is taken to ensure this brochure is as representative as possible however due to the printing process the colours used in your finished glass design may differ slightly from those shown here.

**ABERDEEN** Craigshaw Road, West Tullos Industrial Estate, AB12 3ZG  
Tel: 01224 230000

**LIVINGSTON** 1 Rennie Square, Brucefield Industrial Estate, EH54 9DF  
Tel: 01506 423700

**ELGIN** 1 Pinefield Parade, Pinefield Industrial Estate, IV30 6AG  
Tel: 01343 545222



[www.acyule.com](http://www.acyule.com)